

Rollair®

Rotary Screw Compressors

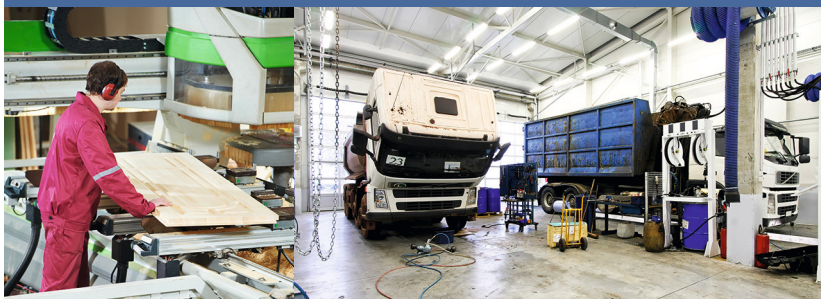

ROLLAIR 40-150E AND ROLLAIR V 40-150E

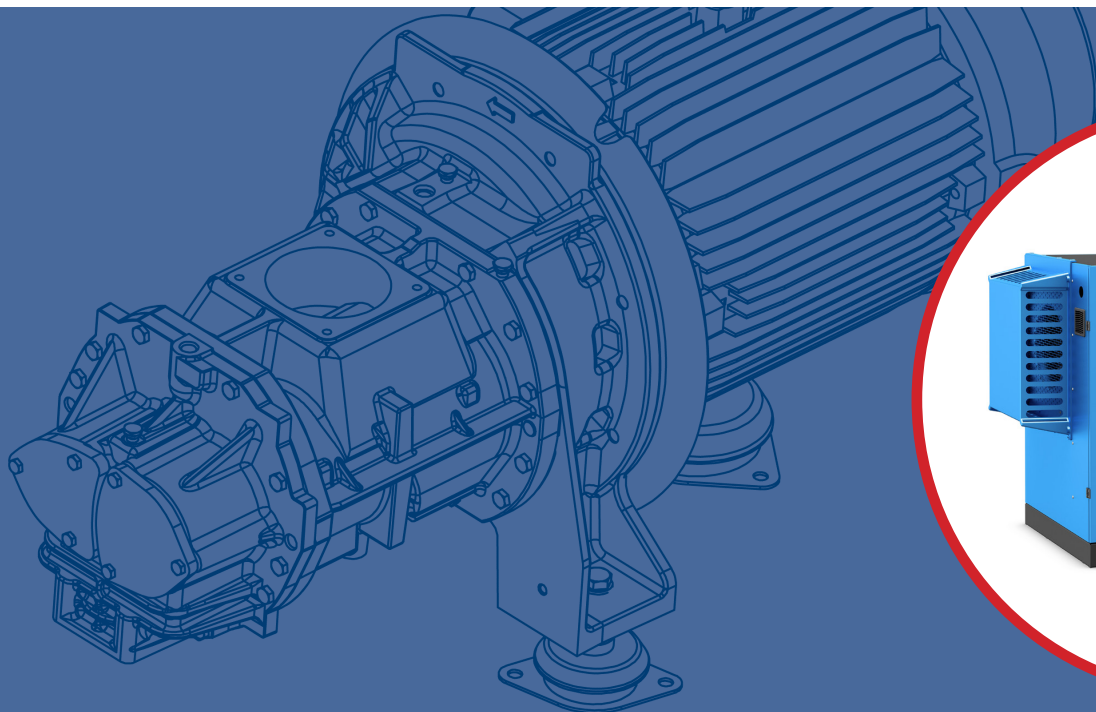

**Worthington
Creyssensac**

Worthington Creyssensac's heritage

Creysensac was founded in Nanterre (near Paris), France in 1934 by Elie Creysensac and quickly became renowned in the automotive industry for developing high quality piston compressors.

In the mid nineteen sixties, screw compressors were added to the product portfolio while 1973 saw the merge with Worthington. This further expanded the influence of the company in the compressed air world and reinforced the distributor network.

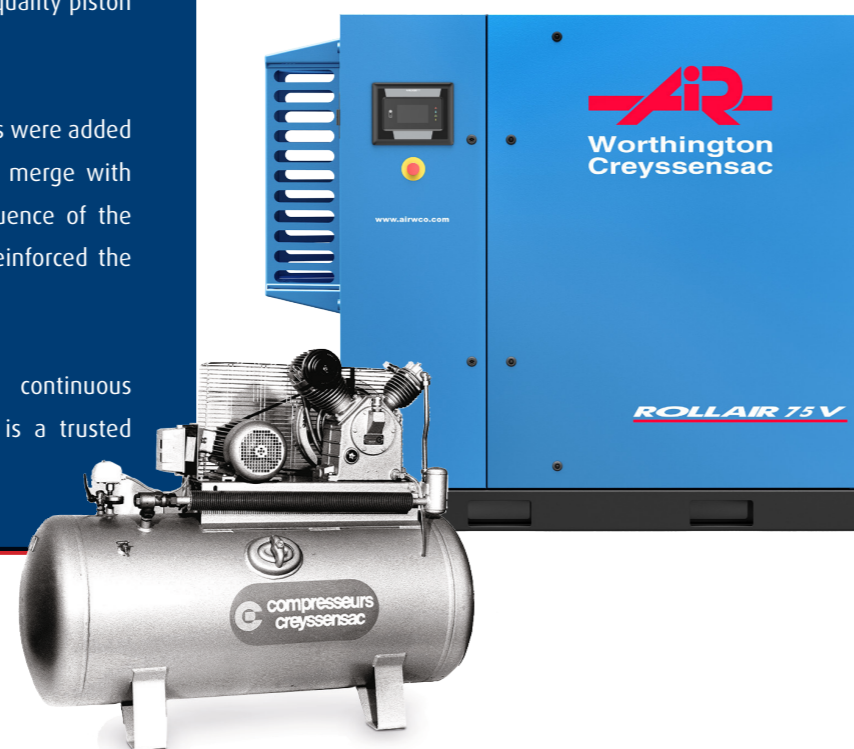
Today, its long-standing experience and continuous innovation ensure Worthington Creyssensac is a trusted partner for its customers.



Driven by technology Designed by experience

Discover what happens when a passion for technology is fused with hands-on industrial experience. Designs evolve towards more practical installation and maintenance, giving you the freedom to focus on your job. Product ranges include the exact machine you need, with the right options for your performance needs. Return on investment is ensured, while your carbon footprint shrinks. And, because we stay close to our customers, we're one step ahead when your needs change.

**INNOVATION
HANDS-ON
EXPERIENCE
PEACE OF MIND
TOTAL COST
OF OWNERSHIP
PARTNERSHIP**

The power of the Rollair range

The Rollair 40-150E screw compressors provide high-quality compressed air for a wide range of industrial applications. With fixed or variable speed drive and an array of other options you can tailor the compressor to match your precise requirements.

Superior efficiency

- In-house design compression elements.
- Direct drive transmission.
- High-efficiency radial cooling fan.
- IE3 / NEMA Premium Efficiency motor.
- Integrated air dryer

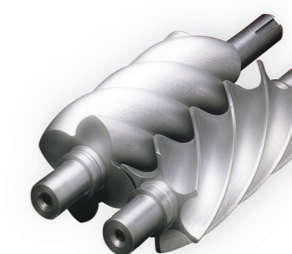

Intelligent control

- Airlogic full colour 4.3 inch HD Touch display.
- Intelligent unload cycle control.
- Precise pressure control.
- Warning indicators.
- Graphical indication service plan.
- Built-in online monitoring.



Ultimate reliability and serviceability

- Proven designs
- Reputed brands
- Modular design.
- Extensive service support.
- Designed for harsh conditions and ambient temperatures up to 46°C.

www.airwco.com

10 reasons to choose Worthington

Check out these innovative features and see how they provide you with high efficiency, ease of maintenance, low noise levels and outstanding cooling.



1. Element and drive train

- Gearbox technology ensuring outstanding efficiency and continued reliability.
- Innovative design resulting in a smaller footprint.

2. High efficiency motors

- IE3 / NEMA Premium efficiency motor (standard on fixed speed machines, optional on variable speed ones).
- IP55, insulation Class.

3. Radial fan

- Low power consumption & reduced noise levels.
- Optimal cooling flow.
- Increased lifetime of oil, consumables and compressor.



4. Standard enclosed intake filter

- Low noise levels thanks to design and position of filter.
- Improved FAD due to air intake positioning.
- High quality filtration to maximize oil quality and protect your compression element.

5. Intelligent controller

- The full-colour Airlogic controller offers a user-friendly interface to access all the compressor parameters, service notifications and events.
- The various control modes and intelligent algorithms allow the compressor to automatically adapt to demand changes.
- Built-in online monitoring allows the user to follow up on the compressor everywhere he goes.

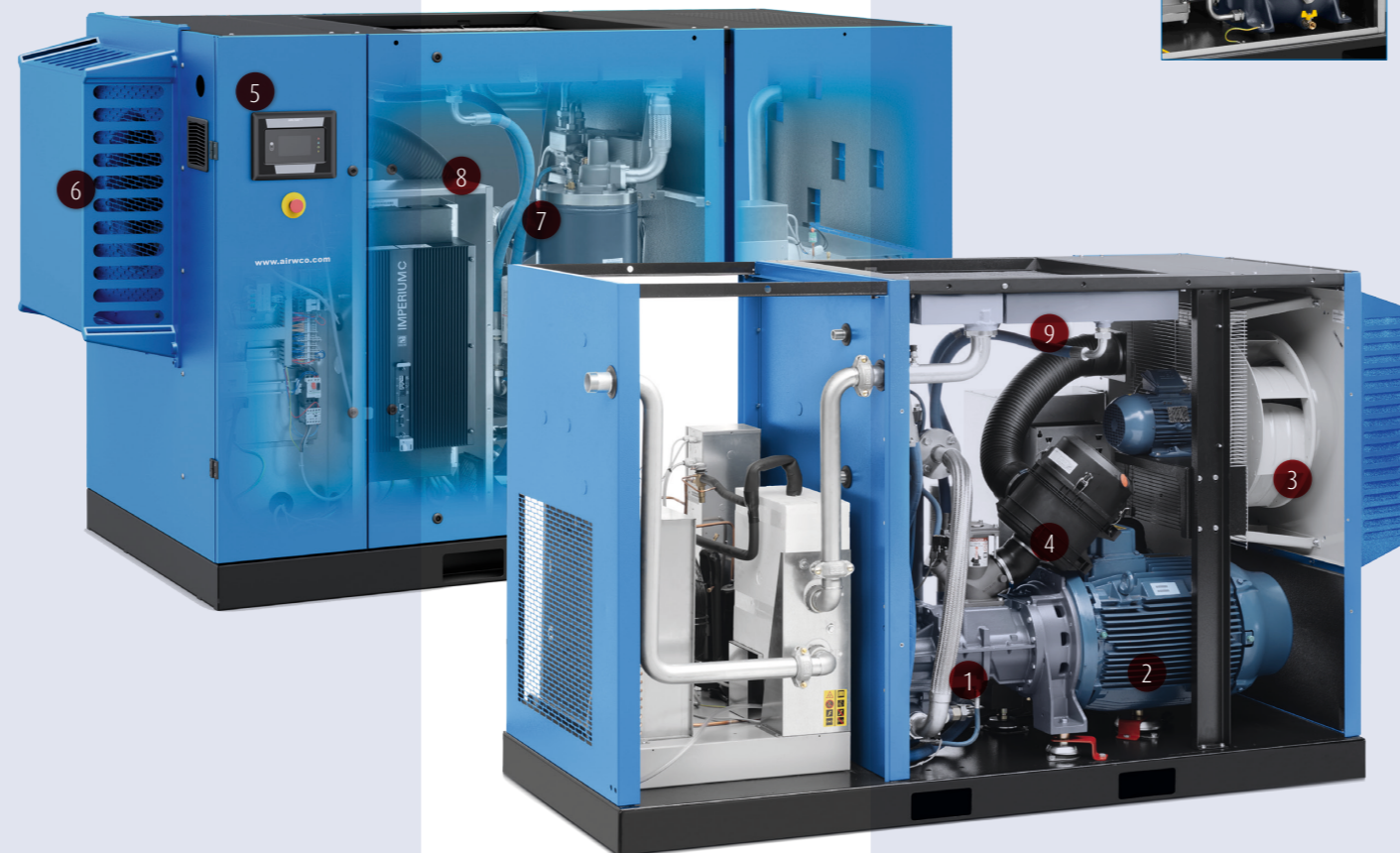

6. Solid inlet baffle

- Small installation footprint: the unit can be placed against a wall.
- Fitted with insulation foam to reduce noise.
- Optimized air flow for improved cooling.
- Added protection for the cooling fan.



7. In-house designed oil separator vessels

- Integrated minimum pressure valve (MPV) eliminates risk of leakage.
- Long lifetime thanks to cast iron parts.
- Designed for optimal oil separation.



8. In-house designed inverter

- Integrated Imperium inverter for RLR 75-150E IVR
- Robust industrial design with IP5X protection rating
- Compact, smart and user-friendly, controlled by Airlogic²
- Installed in a separate cubicle to ensure optimal cooling and easy maintenance

9. Separate coolers

- Separate oil and air cooler for high-quality cooling and long lifetime of the coolers.
- Gliding rails for easy and safe removal.
- Easy access for cleaning.

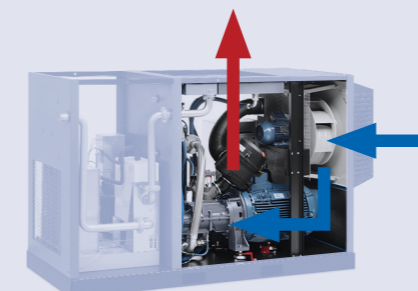

10. Improved motor cooling

- Separate cooling flow.
- Suitable for harsh conditions and temperatures up to 46°C.

Optimize your energy consumption

Did you know that energy costs represent about **70%** of the total operating cost of your compressor over a 5-year period? That's why reducing the energy consumption of our compressed air installation should be a major focus.

Variable speed technology

For the right application, variable speed technology, such as on the Rollair V, can cut the energy bill of your compressor by up to **35%**. The Rollair V reduces energy consumption in the following ways:

- The variable frequency drive compressor matches air supply with demand therefore reducing energy consumption when the demand is lower. If the demand is stable then the Airlogic² controller guarantees a fixed set pressure.
- No unload cycles above 20% load.
- No peak current due to soft start.

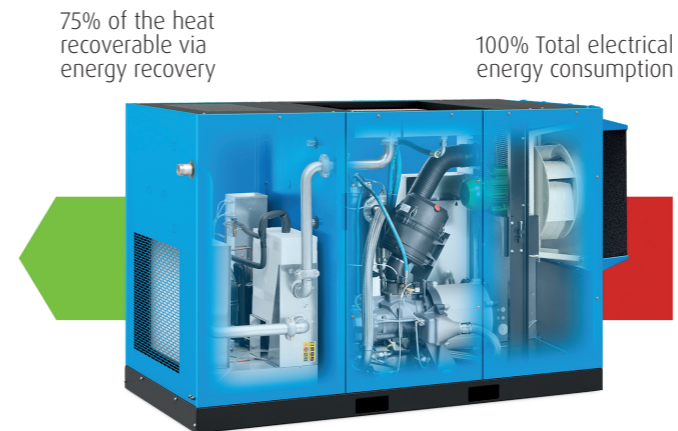
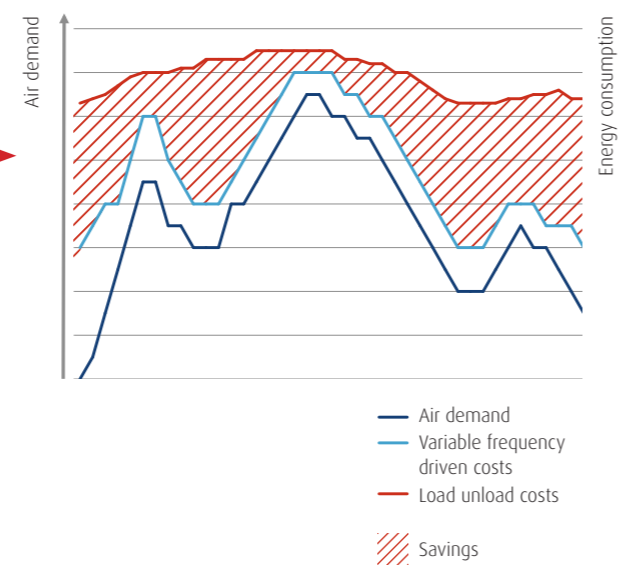
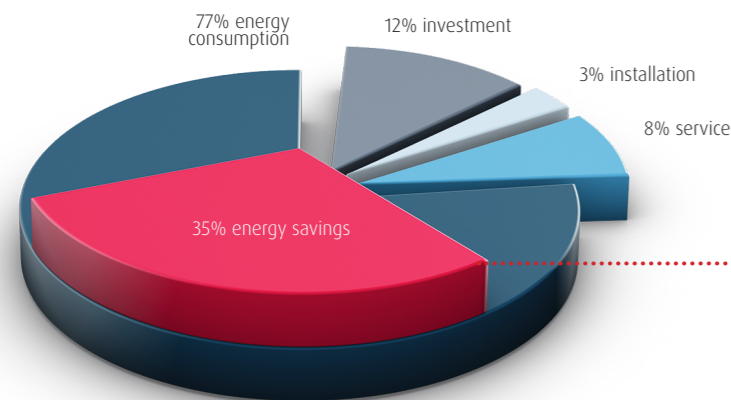

Energy recovery

When air is compressed, heat is formed. The excess heat can be captured with an energy recovery option and channeled to other applications allowing you to save energy and cut costs. The energy recovery option integrates a heat exchanger on the oil circuit, which heats up the continuously pressurized water flow. The system is regulated automatically, and in case of limited water cooling capacity, the standard cooling system of the compressor will operate and backup the energy recovery device.

Airlogic² T touchscreen controller

The new Airlogic² T controller is truly state-of-the-art, maximizing user-friendliness, efficiency and reliability. With a large 4,3" full-colour touchscreen display and 30+ languages, smooth control is at your fingertips. The integrated connectivity with remote monitoring possibilities enables full insight into your compressed air network and helps you to optimize and save energy.



Control and monitoring features:

- Warning indications.
- Graphical indication service plan.
- Integrated ECO6i available as option to central control up to 6 compressors limiting the energy consumption and equalizing running hours across your whole system.
- Online visualization of running conditions.

How much energy could you save in your existing compressor installation?

Contact us for an energy audit. We will measure the air demand and energy consumption of your existing installation and generate a detailed report at the end. Based on your specific situation we can simulate and show how much your energy costs would reduce with your new compressor.



Icons

Connectivity is the future. The Rollair 40-150E | V 40-150E comes fully prepared and enables you to benefit from all the advantages of ICONS:

- Remote monitoring that helps you optimize your compressed air system and save energy.
- On-time maintenance which optimizes costs and ensures a longer machine life.
- Potential problems are recognized before they can pose a threat to the continuity of your production.

Central controller technology

For installations with multiple compressors, a costly cascade system with a wide pressure band used to be the only way to operate. Additionally, the running hours of the compressors were not synchronized making strategic servicing difficult. Install the ECOntrol6 or the integrated compressor control (with a license) and get simple, central control to reduce system pressure and energy consumption in installations of up to 4 or 6 compressors.



Control features

- Single pressure measurement point.
- Minimized pressure band.
- Stable system pressure.
- Equalization of running hours.
- Multiple IVR speed control.
- Clear and visual graphical display.
- Online monitoring and controlling possible.

Enhanced air quality

Many people do not realize that the operating environment can have a major impact on the air quality at the compressor outlet. Even in a dedicated compressor house the inlet air can contain particulate or moisture which can have a negative impact on the production.

The Rollair 40-100E compressors are available with an integrated dryer option, which offers significant advantages compared to a stand-alone dryer:

- Condensation removal at source minimizing pipework corrosion.
- Reduced footprint, up to 1/3rd of a stand-alone dryer.
- Intelligent dryer control, controlled by the Airlogic².
- Higher operating temperatures compared to stand-alone.
- Single service visit, reducing maintenance costs.
- No installation cost.



Options to optimize your operations



Every installation is different, therefore we offer you a wide range of options to enable you to personalize your Rollair 40-150E compressor to your needs.

Air quality

- Internal water separator - reduces up to 90% of the condensate in the compressed air. (standard on Rollair 40-50-60)
- Automatic drain - ensures no air loss during condensate removal (only in combination with internal water separator).
- Tropical thermostatic valve - for use in humid and hot conditions.
- High-efficiency air intake pre-filtration panel - avoids dust entering the compression element, protecting internal components and extending the compressor lifetime.

Energy saving

- Energy recovery pack - recovers up to 75% of the energy formed during the compressor process heat, which can be used to heat up water for boilers, showers etc.

Safety

- Wrong rotation direction control - protects the compressor from possible damage when the power supplied by the energy provider is unreliable.
- Water shut-off valve outside the canopy - for water-cooled machines.
- The oil pre-heater - guarantees a certain oil temperature in the oil vessel to avoid condensation.

Control and monitoring

- ECO 4/6i - integrated multiple compressor control for 4/6 compressors.
- Remote monitoring - for additional convenience.

Available for Rollair 40-50-60:

Extended lifetime oil & filters

- "Plus" option including 4000 hours oil combined with an air and oil filter with the same lifetime.
- "Extended" option including 8000 hours oil with a long lifetime oil filter. This will guarantee optimal performance at all times.

Technical data

Fixed speed version	Max. working pressure	Reference working pressure	Free Air Delivery @ reference conditions*			Motor power		Noise level**	Cooling air volume	Weight		Compressed air output diameter
			m³/h	l/s	cfm	kW	hp			std	T	
RLR 40	7.5	7	357	99	210	30	40	66	6660	626	796	1 1/2"
	8.5	8	324	90	190	30	40	66	6660			
	10	9.5	297	83	175	30	40	66	6660			
	13	12.5	255	71	150	30	40	66	6660			
RLR 50	7.5	7	419	116	247	37	50	67	6660	683	853	1 1/2"
	8.5	8	390	108	229	37	50	67	6660			
	10	9.5	367	102	216	37	50	67	6660			
RLR 60	7.5	7	492	137	290	45	60	68	6660	692	900	1 1/2"
	8.5	8	465	129	273	45	60	68	6660			
	10	9.5	428	119	252	45	60	68	6660			
RLR 75	7.5	7	601	167	354	55	75	70	9000	1130	1403	2"
	8.5	8	572	159	337	55	75	70	9000			
	10	9.5	540	150	318	55	75	69	9000			
	13	12.5	447	124	263	55	75	69	9000			
RLR 100E	7.5	7	774	215	456	75	100	71	12600	1317	1590	2"
	8.5	8	756	210	445	75	100	71	12600			
	10	9.5	677	188	399	75	100	70	12600			
	13	12.5	582	162	343	75	100	70	12600			
RLR 100	7.5	7	882	245	519	75	100	69	12600	1570	NA	2"
	8.5	8	821	228	483	75	100	69	12600			
	10	9.5	742	206	437	75	100	68	12600			
	13	12.5	629	175	370	75	100	68	12600			
RLR 125	7.5	7	986	274	581	90	125	70	14760	1600	NA	2"
	8.5	8	972	270	572	90	125	70	14760			
	10	9.5	868	241	551	90	125	69	14760			
	13	12.5	721	200	425	90	125	69	14760			
RLR 150E	7.5	7	1238	344	729	110	150	74	14760	1800	NA	2"
	8.5	8	1181	328	695	110	150	74	14760			
	10	9.5	1073	298	632	110	150	73	14760			
	13	12.5	907	252	534	110	150	73	14760			

* Unit performance measured according to ISO 1217, Annex C, latest edition.

** Noise level measured according to ISO 2151 with optional baffle.

All technical data for air-cooled machines without integrated dryer. For technical data of water-cooled machines or machines with integrated dryer, please contact your local salesforce.



Dimensions Fixed Speed

Model	Length std	Length T	Width	Height
RLR 40				
RLR 50	1555	2055	890	1790
RLR 60				
RLR 75	1923	2773	1060	1630
RLR 100E				
RLR 100	2125	NA	1060	1630
RLR 125				
RLR 150E	2333	NA	1060	1630

Technical data

Inverter driven version	Working pressure	Min. free air delivery (7 bar)*			Max. free air delivery														
		7 m³/h	7 l/s	7 cfm	7 m³/h	7 l/s	7 cfm	9.5 m³/h	9.5 l/s	9.5 cfm	10 m³/h	10 l/s	10 cfm	12.5 m³/h	12.5 l/s	12.5 cfm	13 m³/h	13 l/s	13 cfm
RLR 40 IVR	4-10	95	27	56	335	93	197	289	80	170	281	78	165	n.a.	n.a.	n.a.	n.a.	n.a.	n.a.
	4-13	83	23	49	291	81	171	289	80	170	289	80	170	236	66	139	229	64	135
RLR 50 IVR	4-10	118	33	69	414	115	244	364	101	214	353	98	208	n.a.	n.a.	n.a.	n.a.	n.a.	n.a.
	4-13	103	29	60	360	100	212	364	101	214	363	101	214	284	79	167	276	77	162
RLR 100 IVR	4-10	251	70	148	874	243	516	752	209	443	730	203	430	n.a.	n.a.	n.a.	n.a.	n.a.	n.a.
	4-13	211	59	124	742	206	437	752	209	443	751	209	442	629	175	370	610	169	359
RLR 125 IVR	4-10	282	78	166	990	275	583	846	235	498	821	228	483	n.a.	n.a.	n.a.	n.a.	n.a.	n.a.
	4-13	243	67	143	851	237	501	846	235	498	845	235	497	721	200	425	700	194	412
RLR 150E IVR	4-10	199	55	117	1145	318	674	1020	283	601	990	275	583	n.a.	n.a.	n.a.	n.a.	n.a.	n.a.
	4-13	167	46	98	960	267	565	954	265	562	952	264	561	883	245	520	857	238	504

* Unit performance measured according to ISO 1217, Annex C, latest edition.

** Noise level measured according to ISO 2151 with optional baffle.

All technical data for air-cooled machines without integrated dryer. For technical data of water-cooled machines or machines with integrated dryer, please contact your local salesforce.

Model	Motor power		Noise level**	Cooling air volume	Weight		Compressed air output diameter
	kW	hp			V kg	VT kg	
RLR 40 IVR	30	40	67	5400	840	1025	1 1/2"
	30	40	66	5400			
RLR 50 IVR	37	50	68	5760	920	1105	1 1/2"
	37	50	67	5760			
RLR 100 IVR	75	100	70	12600	1640	NA	2"
	75	100	69	12600			
RLR 125 IVR	90	125	71	14760	1670	NA	2"
	90	125	70	14760			
RLR 150E IVR	110	150	74	14760	1900	NA	2"
	110	150	73	14760			

Dimensions IVR

Model	Length std	Length T	Width	Height
RLR 40	1684	2333	1060	1630
RLR 50				
RLR 100	2125	NA	1060	1630
RLR 125				
RLR 150E	2333	NA	1060	1630





**Worthington
Creysensac**

DRIVEN BY TECHNOLOGY DESIGNED BY EXPERIENCE



**CONTACT YOUR LOCAL
WORTHINGTON CREYSSENSAC
REPRESENTATIVE.**



Care. Trust. Efficiency.

Care.

Care is what service is all about: professional service by knowledgeable people, using high-quality original parts.

Trust.

Trust is earned by delivering on our promises of reliable, uninterrupted performance and long equipment lifetime.

Efficiency.

Equipment efficiency is ensured by regular maintenance. Efficiency of the service organization is how Original Parts and Service make the difference.

699010303

www.airwco.com